

Quick jaw change ma

JAW S

Chuck takes same jaws as KNCS-N

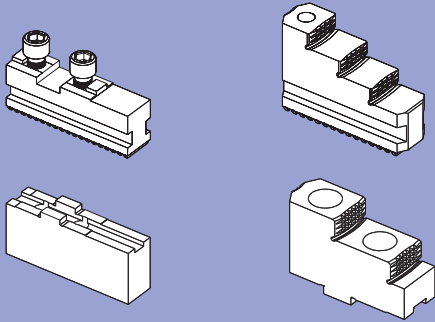

ORIGINAL SMW

HG-N

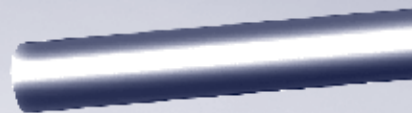

■ Jaw change in less than 1 minute

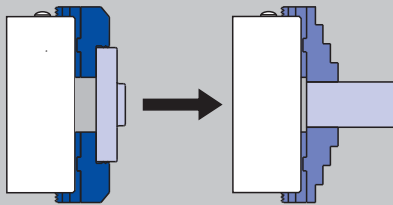

■ Universal, because jaws can be radially adjusted and reversed = less jaw sets

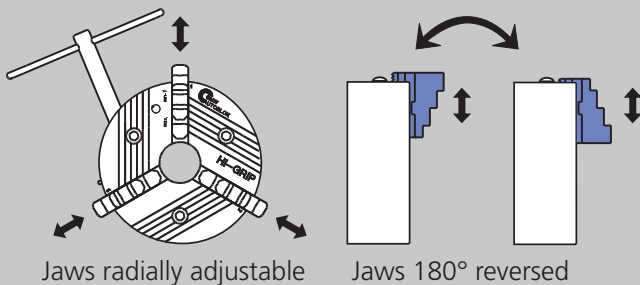

For highest speeds
Flat gripping force curve

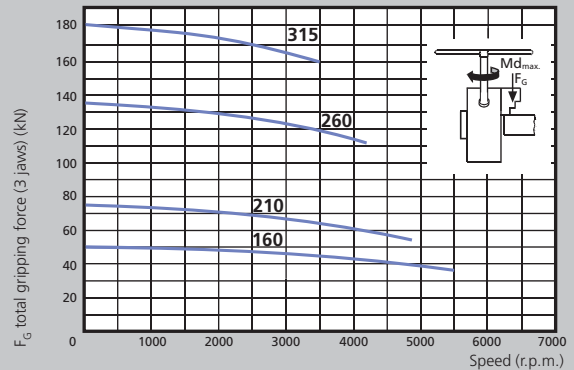

■ The max. gripping force is the total, acting on the 3 jaws, obtained by applying to the chuck the max. allowed driving torque. The data refers to a chuck newly maintained accordingly to their service manual, using SMW K05 grease.

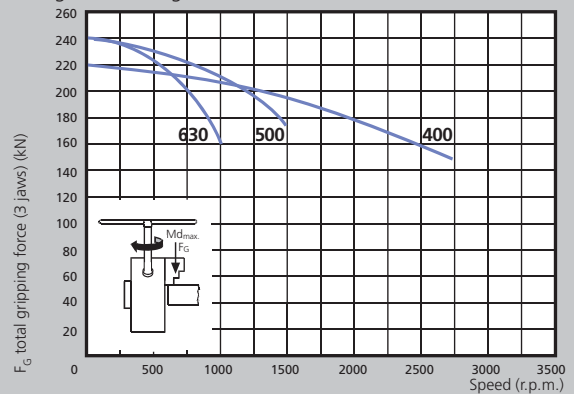

■ The dynamic gripping forces have been measured using hardened standard stepped monoblock jaws type GST placed in a position not exceeding the outer diameter of the chuck.

▲ **Safety advice/danger of damage:**

When using taller/havier jaws and/or clamping on a more external position reduce driving torque/rotating speed accordingly.

Universal chuck HI-GRIP®

Direct mounting

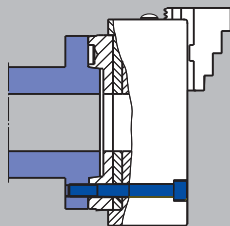

Recess and bolt circle to DIN 55026 / DIN ISO 702/1

■ No re boring of already machined jaws necessary, because of runout < 0.02 (e.g. HG-N 210)

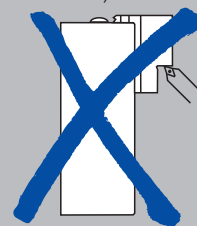

Wedge bar design guarantees highest precision, concentricity and repeatability as well as highest gripping forces

• Safety jaw release with interlock

• Jaw system SMW

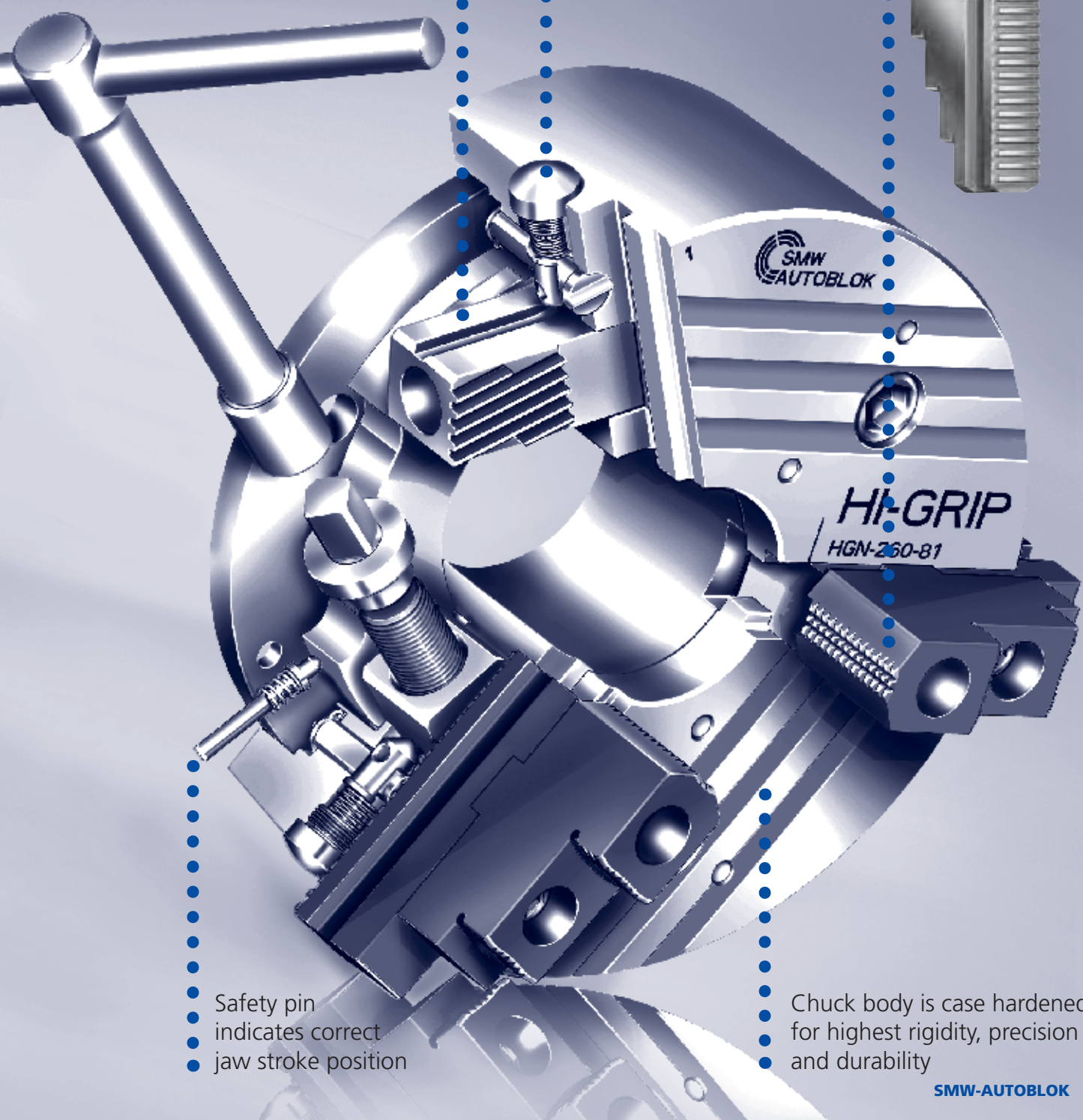

• Safety pin indicates correct jaw stroke position

• Chuck body is case hardened for highest rigidity, precision and durability

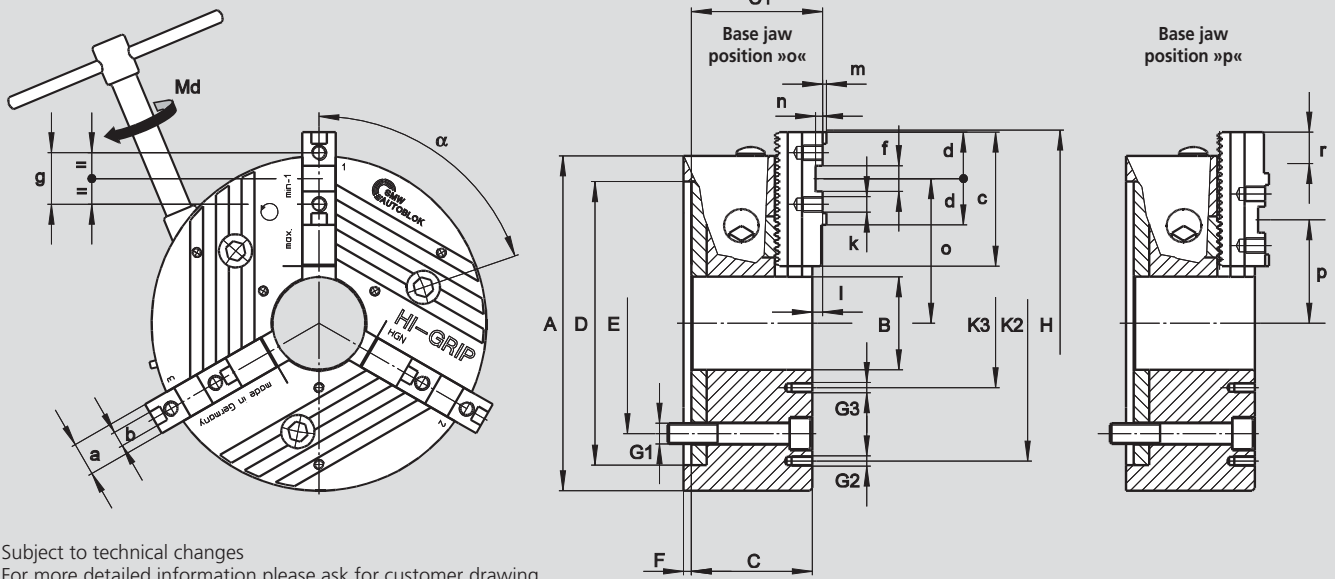

Jaw position: open position for external clamping



Subject to technical changes
For more detailed information please ask for customer drawing

SMW-AUTOBLOK Type HG-N		160-46	210-60	260-81	315-102	400-128	500-165	630-254
Mounting	Size	Z140	Z170	Z220	Z300	Z380	Z380	Z380
	A	165	210	260	315	400	500	630
	B	46	60	81	102	128	165	254
	C	64	85.5	93.7	110.8	125	136	143
	C1	71	90.4	102	120.1	134.3	146	153
H6	D	140	170	220	300	380	380	380
	E	104.8	133.4	171.4	235	330.2	330.2	330.2
	F	5	6	6	6	6	8	8
	G1	M10	M12	M16	M20	M24	M24	M24
	G2	-	M10/3 x 120°	M10/3 x 120°	M10/3 x 120°	M12/3 x 120°	M16/9 x 40°	M16/6 x 60°
	G3	M5/3 x 120°	M6/3 x 120°	M8/3 x 120°	M10/3 x 120°	M12/3 x 120°	M12/3 x 120°	M12/3 x 120°
Swing dia.	H	194	244	300	358	426	530	685
	K2	-	168	210	268	330	420	550
	K3	75	75	95	120	152	195	290
	α°	76	74	71	71	71	71	74
	β°	-	60	60	60	60	20	30
Master jaw		GBK 160	GBK 200	GBK 250	GBK 315	GBK 400	GBK 500	GBK 630
	a	20	22	26	32	32	45	45
f7	b	8	10	12	12	12	18	18
	c	65	85	104	115	125	160	200
	d	28	33	36	36	43	50	50
H7	f	18	20	20	20 (26)	26	30	30
	g	32	40	40	40 (54)	54	60	60
Thread/thread depth	k	M8/12	M8/13	M12/15	M12/17	M12/17	M16/34	M16/34
	l	6	4.9	8.3	9.3	9.3	10	10
	m	2.5	2.5	3	3	3	4	4
	n	5	4.5	5.5	6	7	9	9
max./min.	o	69/51.2	88/64.5	112.4/79.4	141.3/102.8	168.8/113.8	211/141	291.5/200.5
max./min.	p	59.3/40.5	69/45.5	80.6/47.6	97.3/58.8	129.8/74.8	150/80	191.5/100.5
Base jaw tooth pitch	-	4.7	4.7	5.5	5.5	5.5	7	7
Master jaw offset	r	18.8	23.5	33	38.5	55	70	91
Master jaw offset	teeth	4	5	6	7	10	10	10
Usable jaw stroke	mm	5.9	6.4	7.4	9.6	11.4	11.5	13
max. total gripping force	kN	60	75	130	180	220	250	250
at max. torque Md	Nm	80	120	160	200	250	260	260
Speed	r.p.m	5500	4800	4200	3500	2700	1500	1000
Weight without jaws	kg	8.3	19	32	53	103	161	270
Moment of inertia	kg·m ²	0.03	0.09	0.25	0.60	1.9	4.5	12

Ordering review

Chuck with center mounting DIN 6350	HG-N	160-46		210-60			260-81		315-102		400-128		500-165		630-254		
	Mounting	Z140	Z140		Z170			Z220		Z300		Z380		Z380		Z380	
	C	64	64		85.5			94		111		125		136		136	
	D	140	140		170			220		300		380		380		380	
	E	104.8	104.8		133.4			171.4		235		330.2		330.2		330.2	
Chuck with GBK + WAK																	
	Id. No.	Id. No.		Id. No.			Id. No.		Id. No.		Id. No.		Id. No.		Id. No.		
	089310	089310		089538			089550		089562		089574		089584		089708		
Chuck with GST																	
	Id. No.	Id. No.		Id. No.			Id. No.		Id. No.		Id. No.		Id. No.		Id. No.		
	089312	089312		089313			089317		089321		089325		089328		089709		
Chuck with GBK + GUA																	
	Id. No.	Id. No.		Id. No.			Id. No.		Id. No.		Id. No.		Id. No.		Id. No.		
	089331	089331		089539			089551		089563		089575		089585		089710		

Chuck with ISO-A mounting DIN 55026	HG-N	160-46		210-60			260-81		315-102		400-128		500-165		630-254	
	Mounting	A4	A5	A5	A6	A8	A6	A8	A8	A11	A11	A15	A11	A15	A11	A15
	C	84	79	109.5	107.5	125.5	118	119	141	141	165	161	176	172	176	172
	D	63.52	82.57	82.57	106.39	139.73	106.39	139.73	139.73	196.88	196.88	285.77	196.88	285.77	196.88	285.77
	E	82.6	104.8	104.8	133.4	171.4	133.4	171.4	171.4	235.0	235.0	330.2	235.0	330.2	235.0	330.2
Chuck with GBK + WAK																
	Id. No.	Id. No.	Id. No.	Id. No.	Id. No.	Id. No.	Id. No.	Id. No.	Id. No.	Id. No.	Id. No.	Id. No.	Id. No.	Id. No.	Id. No.	
	089332	089342	090458	089540	089542	089552	089554	089564	089566	089576	089578	089586	089588	089711	089713	
Chuck with GST																
	Id. No.	Id. No.	Id. No.	Id. No.	Id. No.	Id. No.	Id. No.	Id. No.	Id. No.	Id. No.	Id. No.	Id. No.	Id. No.	Id. No.	Id. No.	
	089962	089346	090459	089314	089315	089318	089319	089322	089323	089326	089327	089329	089330	089715	089732	
Chuck with GBK + GUA																
	Id. No.	Id. No.	Id. No.	Id. No.	Id. No.	Id. No.	Id. No.	Id. No.	Id. No.	Id. No.	Id. No.	Id. No.	Id. No.	Id. No.	Id. No.	
	089427	089434	090460	089541	089543	089553	089555	089565	089567	089577	089579	089587	089589	089749	089760	

Chuck with bayonet mounting DIN 55027 Type C	HG-N	160-46		210-60			260-81		315-102		400-128		500-165		630-254	
	Mounting	C4	C5	C5	C6	C8	C6	C8	C8	C11	C11	C15	C11	C15	C11	C15
	C	84	84	107.5	107.5	125.5	119	119	141	141	161	161	172	172	172	172
	D	63.52	82.57	82.57	106.39	139.73	106.39	139.73	139.73	196.88	196.88	285.77	196.88	285.77	196.88	285.77
	E	85	104.8	104.8	133.4	171.4	133.4	171.4	171.4	235.0	235.0	330.2	235.0	330.2	235.0	330.2
Chuck with GBK + WAK																
	Id. No.	Id. No.	Id. No.	Id. No.	Id. No.	Id. No.	Id. No.	Id. No.	Id. No.	Id. No.	Id. No.	Id. No.	Id. No.	Id. No.	Id. No.	
	089464	089487	090461	089544	089546	089556	089558	089568	089570	089580	089582	089590	089592	089761	089762	
Chuck with GST																
	Id. No.	Id. No.	Id. No.	Id. No.	Id. No.	Id. No.	Id. No.	Id. No.	Id. No.	Id. No.	Id. No.	Id. No.	Id. No.	Id. No.	Id. No.	
	089488	089489	090462	089478	089479	089480	089476	089481	089482	089483	089484	089485	089486	089765	089766	
Chuck with GBK + GUA																
	Id. No.	Id. No.	Id. No.	Id. No.	Id. No.	Id. No.	Id. No.	Id. No.	Id. No.	Id. No.	Id. No.	Id. No.	Id. No.	Id. No.	Id. No.	
	089518	089519	090463	089545	089547	089557	089559	089569	089571	089581	089583	089591	089593	089786	089802	

Chuck with camlock mounting DIN 55029 Type S	HG-N	160-46		210-60			260-81		315-102		400-128		500-165		630-254	
	Mounting	S4	S5	S5	S6	S8	S6	S8	S8	S11	S11	S15	S11	S15	S11	S15
	C	92	92	118.5	118.5	125.5	132	132	154	154	175	175	186	186	186	186
	D	63.52	82.57	82.57	106.39	139.73	106.39	139.73	139.73	196.88	196.88	285.77	196.88	285.77	196.88	285.77
	E	82.6	104.8	104.8	133.4	171.4	133.4	171.4	171.4	235.0	235.0	330.2	235.0	330.2	235.0	330.0
Chuck with GBK + WAK																
	Id. No.	Id. No.	Id. No.	Id. No.	Id. No.	Id. No.	Id. No.	Id. No.	Id. No.	Id. No.	Id. No.	Id. No.	Id. No.	Id. No.	Id. No.	
	089520	089528	090464	089901	089905	089909	089913	089917	089921	089925	089929	089933	089937	089803	089832	
Chuck with GST																
	Id. No.	Id. No.	Id. No.	Id. No.	Id. No.	Id. No.	Id. No.	Id. No.	Id. No.	Id. No.	Id. No.	Id. No.	Id. No.	Id. No.	Id. No.	
	089602	089663	089996	089899	089903	089907	089911	089915	089919	089923	089927	089931	089935	089843	089897	
Chuck with GBK + GUA																
	Id. No.	Id. No.	Id. No.	Id. No.	Id. No.	Id. No.	Id. No.	Id. No.	Id. No.	Id. No.	Id. No.	Id. No.	Id. No.	Id. No.	Id. No.	
	089668	089674	090466	089902	089906	089910	089914	089918	089922	089926	089930	089934	089938	089942	089955	

Parts included: Fixing elements (screws resp. studs resp. camlock bolts)

QUICK JAW CHANGE

GBK

Hardened base jaws

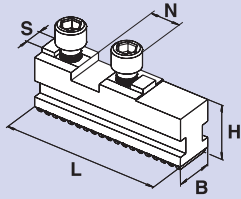

Chuck	HG-N 160	HG-N 210	HG-N 260	HG-N 315	HG-N 400	HG-N 500	HG-N 630
Jaw type	GBK 160	GBK 200	GBK 250	GBK 315	GBK 400	GBK 500	GBK 630
Id. No.	012439	012440	012441	012442	012443	012444	012445
B	20	22	26	32	32	45	45
H	27.5	29.5	37	43	43	57	57
L	65	85	104	115	125	160	200
N	18	20	20	20	26	30	30
S	8	10	12	12	12	18	18
kg/set	0.7	1.0	1.8	2.7	3.0	7.1	9.0

WAK

Soft top jaws

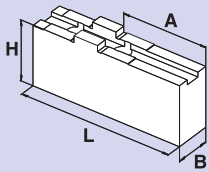

Chuck	HG-N 160	HG-N 210	HG-N 260	HG-N 315	HG-N 400	HG-N 500	HG-N 630
Jaw type	WAK 160-10	WAK 200-10	WAK 250-10	WAK 250-10	WAK 400-10	WAK 500-10	WAK 500-10
Id. No.	012491	012492	012493	012493	012494	012495	012495
B	20	22	30	30	35	50	50
H	35.5	42	50	50	54	75.5	75.5
L	85	105	125	125	145	180	180
A	42	50	70	70	74	100	100
kg/set	1.2	2.0	3.6	3.6	5.8	13.7	13.7

WAKS

Wide soft top jaws

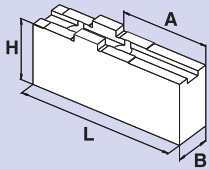

Chuck	HG-N 160	HG-N 210	HG-N 260	HG-N 315	HG-N 400	HG-N 500	HG-N 630
Jaw type	WAKS 140-10	WAKS 200-30	WAKS 250-20	WAKS 250-30	WAKS 400-30	WAKS 500-30	WAKS 500-30
Id. No.	012496	012497	012498	012499	012500	012501	012501
B	35	40	60	80	80	90	90
H	35.5	36	55	55	64	73	73
L	63	70	90	90	100	130	130
A	25	27	44	44	44	65	65
kg/set	1.5	1.9	6.2	8.5	11.0	16.4	16.4

UVB

Soft monoblock jaws

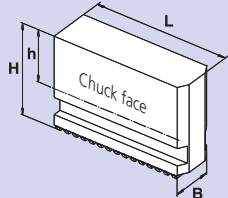

Chuck	HG-N 160	HG-N 210	HG-N 260	HG-N 315	HG-N 400	HG-N 500	HG-N 630
Jaw type	UVB 160	UVB 200	UVB 250	UVB 315	UVB 400	UVB 500	UVB 630
Id. No.	012447	012448	012449	012450	012451	012452	012453
B	20	22	26	32	32	45	45
H	60	70	90	100	100	134	134
h	40	45	61	66	66	87	87
L	69	83	107	119	146.5	175	230
kg/set	1.7	2.8	4.2	6.9	10	23	30

GST

Hardened stepped monoblock jaws

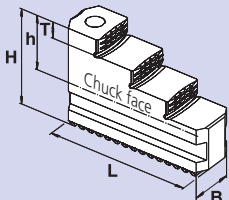

Chuck	HG-N 160	HG-N 210	HG-N 260	HG-N 315	HG-N 400	HG-N 500	HG-N 630
Jaw type	GST 170	GST 210	GST 260	GST 315	GST 400	GST 500	GST 500
Id. No.	035867	035863	037623	012457	012458	012459	012459
B	20	22	26	32	32	45	45
H	43.5	51	60	66	70	93	93
h	23	26	31	32	36	46	46
L	65	84	100	117	137	175	175
T	7	8	10	10	11	20	20
kg/set	0.7	1.3	1.9	3.4	4.4	11.7	11.7
A1	6-59	10-96	10-98	20-115	48-173	65-195	153-313
A2	42-89	56-130	62-150	85-180	116-238	160-285	241-401
A3	73-120	96-170	111-200	140-235	184-308	310-435	391-551
A4	104-151	136-210	161-250	195-290	252-378	-	-
J1	44-78	70-147	63-149	80-170	118-243	-	-
J2	74-110	109-187	112-199	135-225	186-310	170-295	254-414
J3	105-141	149-228	161-249	190-282	253-378	320-445	404-564
J4	135-182	186-260	212-300	255-350	328-448	-	-
S	198	244	303	350	456	540	660

Clamping ranges

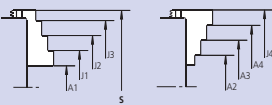

For additional jaw options & accessories please request our 150 page special catalogue!

GUA
Hardened reversible stepped top jaws

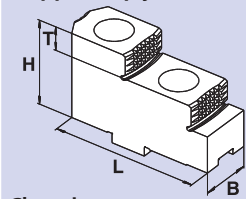

Clamping ranges

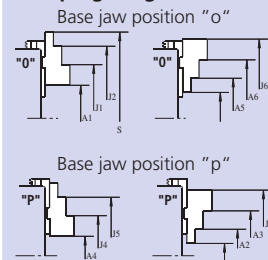

Chuck	HG-N 160	HG-N 210	HG-N 260	HG-N 315	HG-N 400	HG-N 500	HG-N 630
Jaw type	GUA 160	GUA 200	GUA 250	GUA 250	GUA 400	GUA 500	GUA 500
Id. No.	012484	012485	012486	012486	012487	012488	012488
B	20	22	30	30	36	45	45
H	36.5	38	50	50	56	70	70
L	63	72	90	90	105	130	130
T	7.5	10	14	14	15	20	20
kg/set	0.6	0.8	1.9	1.9	3.2	10.8	10.8
A1	32-69	55-111	73-161	120-205	138-258	190-336	190-336
A2	60-98	69-125	45-101	48-120	78-188	80-200	80-200
A3	85-123	96-152	125-181	130-200	186-298	200-320	200-320
A4	13-51	17-73	20-97	36-188	60-183	55-200	55-200
A5	78-116	104-163	76-165	120-205	143-268	190-335	190-335
A6	103-141	131-190	156-245	205-285	253-378	315-455	315-455
J1	91-129	117-174	152-240	202-285	218-338	305-450	305-450
J2	116-154	144-201	233-321	280-365	328-448	425-570	425-570
J3	144-181	158-215	204-259	208-280	263-380	335-450	335-450
J4	74-111	80-136	101-177	110-200	138-263	170-310	170-310
J5	99-136	107-163	180-257	198-280	248-373	290-430	290-430
J6	162-200	193-253	235-323	276-365	333-458	425-570	425-570
S	198	196-253/255	333	390	-	590	590

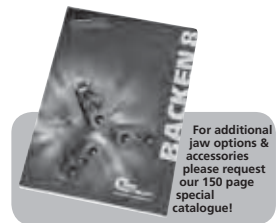

Important for maintenance and safe operation, to be ordered with the chuck

Grease K05®

Special grease for manual and power chucks



Cartridge 14 Oz. (DIN 1284)
Grease content 500 g
Id. No. 016440



Can 1000 g
Id. No. 011881

- High adhesion
- High resistance against coolant
- High load bearing capacity
- Low friction coefficient
- High gripping force
- Avoids tribocorrosion

Grease gun

Grease gun (DIN 1283) for cartridges 14 Oz. (DIN 1284).

- Also refillable from grease can 1000 g.



Lubrication set Id. No. 083726

Supply range

- Grease gun
- 1 Adapter flexible for high pressure grease nipple
- 1 Adapter for cone grease nipple