

# SIN-S

Closed center  
rotating hydraulic cylinder

## Closed center rotating hydraulic cylinder

- up to 70 bar
- central bore for media supply
- stroke control via proximity switch or linear positioning system



### Application/customer benefits

- Actuation of power chucks/closed or partial open center mounting applications

### Technical features

- Pressure range 7–70 bar
- Horizontal or vertical installation
- Central bore for coolant, oil or air with thread for rotary union
- Safety valves and excess pressure relief valve
- Mounting from the rear or from the front side
- Stroke control via proximity switch or linear positioning system
- A 10 µm filter in pressure line is requested
- Use oil HM32 ISO 3448

### SIN-S standard version

- Central bore + thread for rotary union

#### Ordering example

##### SIN-S standard version

- Cylinder SIN-S 125 Id. No. 33093112
- Rotary union Id. No. 043271 (proximity switch not included)

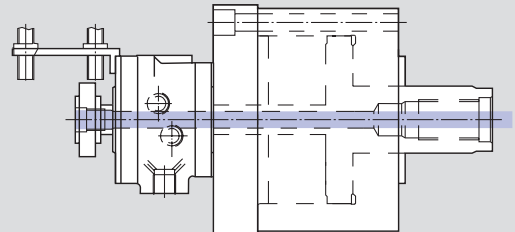
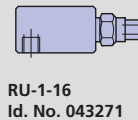
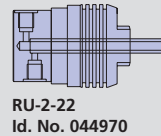

### SIN-PXP with linear positioning system

- Central bore + thread for rotary union

#### Ordering example

##### SIN-S standard version

- (1)\* Cylinder SIN-S 125 prepared for PXP/LPS Id. No. 77093112
- (2)\* Kit PXP (bracket and taper) Id. No. 60557915 (sensor not included)
- Rotary union Id. No. 044970

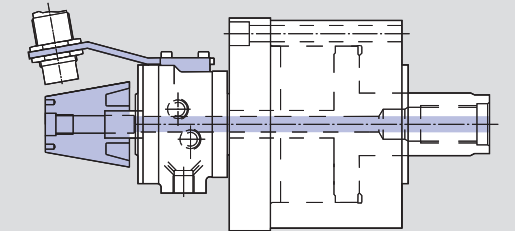
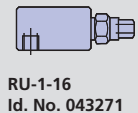
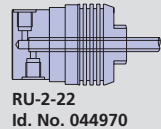

\* **Attention:** PARTS (1) and PART (2) can be supplied as assembled with the single part number 33092912 (see table below "SIN-S equipped with kit PXP")

### SIN-LPS-X with linear positioning system

- Central bore + thread for rotary union

#### Ordering example

##### SIN-S standard version

- Cylinder SIN-S 125 prepared for PXP/LPS Id. No. 77093112
- Kit LPS-X (bracket and cam) Id. No. 044503 (LPS-X not included see page 241)
- Rotary union Id. No. 044970

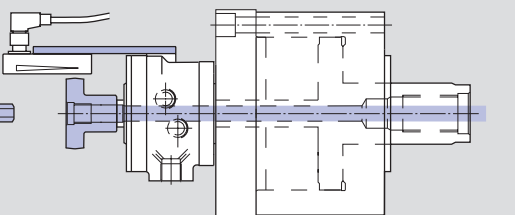
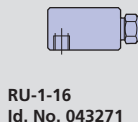
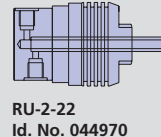

## Technical data

SMW-AUTOBLOK Type		SIN-S 50	SIN-S 70	SIN-S 85	SIN-S 100	SIN-S 125	SIN-S 150	SIN-S 175	SIN-S 200	SIN-S 250
<b>SIN-S standard version</b>		33093105	33093107	33093109	33093110	33093112	33093115	33093117	33093120	33093125
<b>SIN prepared for PXP/LPS</b>		77093105	77093107	77093109	77093110	77093112	77093115	77093117	77093120	77093125
<b>Kit PXP</b>		60557910	60557915	60557910	60557910	60557915	60557915	60557915	60557920	60557920
<b>Kit LPS-X</b>		044503	044503	044503	044503	044503	044503	044503	044496	60557625
<b>SIN-S equipped with kit PXP</b>		33092905	33092907	33092909	33092910	33092912	33092915	33092917	33092920	33092925
<b>Piston area</b>	cm <sup>2</sup>	14	28	48	66	103	157	212	280	457
<b>Max. pressure</b>	bar	70	70	70	70	70	70	70	70	50
<b>Draw pull at 40 bar</b>	kN	5.5	11	19	26	41	62	84	112	180
<b>Oil leakage <sup>1</sup></b>	dm <sup>3</sup> /min	1.5	1.5	1.5	1.5	1.5	1.5	1.5	2	2
<b>Max. speed</b>	r.p.m.	7000	7000	7000	7000	6000	6000	5000	4000	2000
<b>Weight</b>	kg	8.5	8.5	8	11	16	20	24	45	88
<b>Moment of inertia J</b>	kg·m <sup>2</sup>	0.012	0.012	0.012	0.016	0.04	0.08	0.12	0.32	0.92

<sup>1</sup> Total at 30 bar and 50°C

# Closed center rotating hydraulic cylinder

# SIN-S

- up to 70 bar
- central bore for media supply
- stroke control via proximity switch or linear positioning system

Closed center  
rotating cylinder

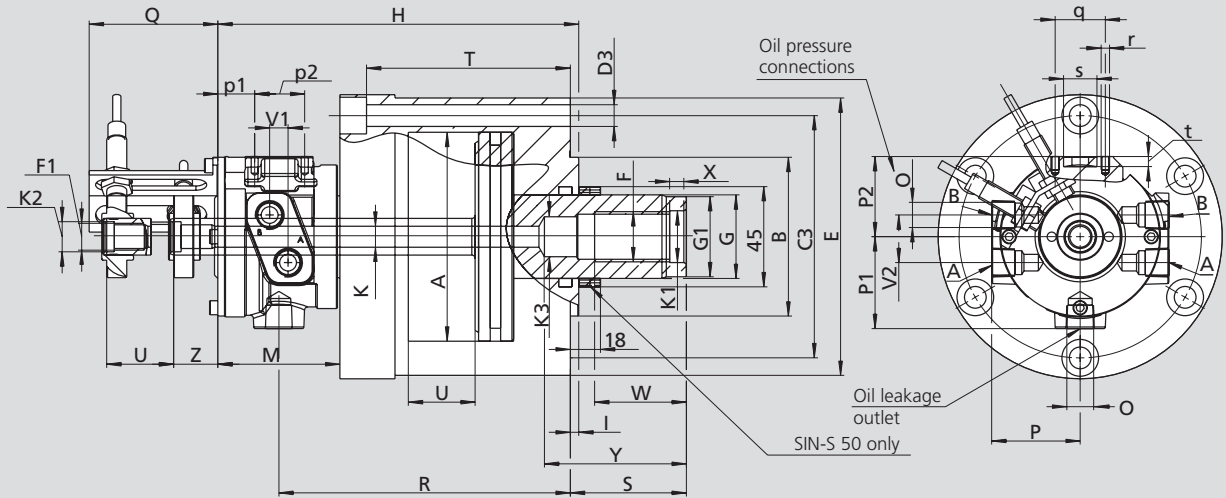

Subject to technical changes  
For more detailed information please ask for customer drawing

SMW-AUTOBLOK Type		SIN-S 50	SIN-S 70	SIN-S 85	SIN-S 100	SIN-S 125	SIN-S 150	SIN-S 175	SIN-S 200	SIN-S 250
A	mm	53	68	85	100	125	150	175	200	250
B	h6 mm	50	50	50	80	95	95	125	125	160
C3	mm	100	100	100	120	145	170	195	225	275
D3	mm	6 x 9	6 x 9	6 x 9	6 x 11	6 x 13	6 x 13	6 x 13	6 x 17	6 x 17
E	mm	120	120	120	140	166	192	217	250	300
F	mm	M20 x 1.5	M20 x 1.5	M20 x 1.5	M24	M30	M30	M36	M42 x 3	M42 x 3
F1	lefthand for rotary union mm	M16 x 1.5	M16 x 1.5	M16 x 1.5	M16 x 1.5	M16 x 1.5	M16 x 1.5	M16 x 1.5	M16 x 1.5	M16 x 1.5
G	mm	32	32	32	40	50	50	60	65	65
G1	h7 mm	30	30	30	38	48	48	58	62	62
H	mm	200	200	192	196	216	216	226	288	313
I	mm	5	5	5	5	5	5	5	5	5
K	mm	12.5	12.5	12.5	12.5	12.5	12.5	12.5	12.5	12.5
K1	mm	20.5	20.5	20.5	25	31	31	37	44	44
K2	J6 mm	18	18	18	18	18	18	18	18	18
K3	H8 mm	17	17	17	18	24	24	28	-	-
M	mm	73	73	73	73	73	73	73	123	123
O	inch	G 3/8"	G 3/8"	G 3/8"	G 3/8"	G 3/8"	G 3/8"	G 3/8"	G 1/2"	G 1/2"
P	mm	55	55	55	55	55	55	55	65	65
P1	mm	55	55	55	55	55	55	55	65	65
P2	mm	48	48	48	48	48	48	48	59	59
Q	mm	77	77	77	77	77	77	77	97	97
R	mm	158.5	158.5	150.5	154.5	174.5	174.5	184.6	238	268
S	max./min. mm	55/30	55/15	47/15	47/15	70/30	70/30	70/25	80/30	85/25
T	mm	112	112	104	104	122	122	132	140	160
U	piston stroke mm	25	40	32	32	40	40	45	50	60
V1	mm	10	10	10	10	10	10	10	12	12
V2	mm	30	30	30	30	30	30	30	36	36
W	mm	40	40	40	45	55	55	55	60	60
X	mm	10	10	10	10	10	10	10	12	12
Y	mm	67	67	67	72	85	85	92	-	-
Z	mm	27	27	27	27	27	27	27	27	27
p1	mm	23.5	23.5	23.5	23.5	23.5	23.5	23.5	36	36
p2	mm	30	30	30	30	30	30	30	30	30
q	mm	30	30	30	30	30	30	30	30	30
r	mm	M5	M5	M5	M5	M5	M5	M5	M5	M5
s	H8 mm	20	20	20	20	20	20	20	20	20
t	mm	6	6	6	6	6	6	6	6	6